

■ Features

- $V_{DS} (V) = -30V$
- $I_D = -2.6 A (V_{GS} = -10V)$
- $R_{DS(ON)} < 130m\ \Omega (V_{GS} = -10V)$
- $R_{DS(ON)} < 200m\ \Omega (V_{GS} = -4.5V)$
- Pb-Free Package May be Available. The G-Suffix Denotes a Pb-Free Lead Finish

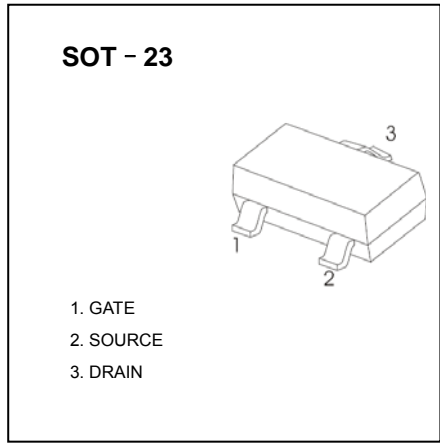

MARKING

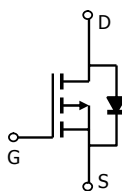

■ Absolute Maximum Ratings $T_a = 25^\circ C$

Parameter	Symbol	Rating	Unit
Drain-Source Voltage	V_{DS}	-30	V
Gate-Source Voltage	V_{GS}	± 20	V
Continuous Drain Current	I_D	$T_A=25^\circ C$	A
		$T_A=70^\circ C$	
Pulsed Drain Current	I_{DM}	-20	
Power Dissipation	P_D	$T_A=25^\circ C$	W
		$T_A=70^\circ C$	
Thermal Resistance. Junction-to-Ambient	R_{thJA}	125	$^\circ C/W$
Thermal Resistance. Junction-to-Case	R_{thJC}	80	$^\circ C/W$
Junction and Storage Temperature Range	T_J, T_{STG}	-55 to 150	$^\circ C$

■ Electrical Characteristics Ta = 25°C

Parameter	Symbol	Testconditions	Min	Typ	Max	Unit
Drain-Source Breakdown Voltage	V _{DSS}	I _D =250 μ A, V _{GS} =0V	-30			V
Zero Gate Voltage Drain Current	I _{DSS}	V _{DS} =-24V, V _{GS} =0V			-1	μ A
		V _{DS} =-24V, V _{GS} =0V, T _J =55°C			-5	
Gate-Body leakage current	I _{GSS}	V _{DS} =0V, V _{GS} =±20V			±100	nA
Gate Threshold Voltage	V _{GS(th)}	V _{DS} =V _{GS} I _D =-250 μ A	-1	-1.9	-3	V
Static Drain-Source On-Resistance	r _{DS(ON)}	V _{GS} =-10V, I _D =-2.6A		97	130	mΩ
		V _{GS} =-10V, I _D =-2.6A T _J =125°C		135	150	
		V _{GS} =-4.5V, I _D =-2A		166	200	mΩ
On state drain current	I _{D(ON)}	V _{GS} =-4.5V, V _{DS} =-5V	-5			A
Forward Transconductance	g _{fs}	V _{DS} =-5V, I _D =-5A	3	3.8		S
Input Capacitance	C _{iss}	V _{GS} =0V, V _{DS} =-15V, f=1MHz		302	370	pF
Output Capacitance	C _{oss}			50.3		pF
Reverse Transfer Capacitance	C _{rss}			37.8		pF
Gate resistance	R _g	V _{GS} =0V, V _{DS} =0V, f=1MHz		12	18	Ω
Total Gate Charge (10V)	Q _g	V _{GS} =-4.5V, V _{DS} =-15V, I _D =-2.6A		6.8	9	nC
Total Gate Charge (4.5V)				2.4		nC
Gate Source Charge	Q _{gs}			1.6		nC
Gate Drain Charge	Q _{gd}			0.95		nC
Turn-On DelayTime	t _{D(on)}		V _{GS} =-10V, V _{DS} =-15V, R _L =5.8 Ω, R _{GEN} =3 Ω		7.5	
Turn-On Rise Time	t _r			3.2		ns
Turn-Off DelayTime	t _{D(off)}			17		ns
Turn-Off Fall Time	t _f			6.8		ns
Body Diode Reverse Recovery Time	t _{rr}	I _F =-2.6A, dI/dt=100A/ μ s		16.8	22	ns
Body Diode Reverse Recovery Charge	Q _{rr}	I _F =-2.6A, dI/dt=100A/ μ s		10		nC
Maximum Body-Diode Continuous Current	I _S				-2	A
Diode Forward Voltage	V _{SD}	I _S =-1A, V _{GS} =0V		-0.82	-1	V

* Repetitive rating, pulse width limited by junction temperature.

■ Typical Characteristics

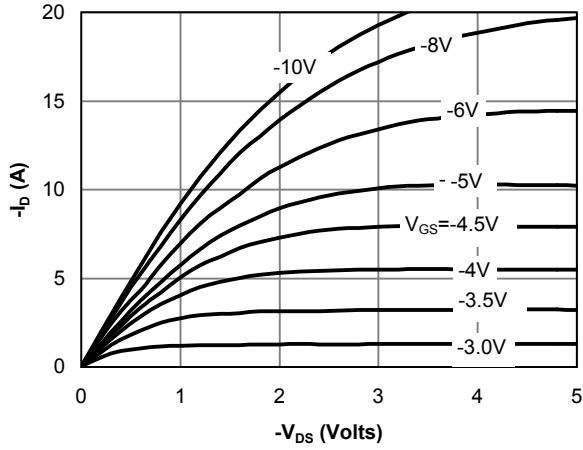

Fig 1: On-Region Characteristics

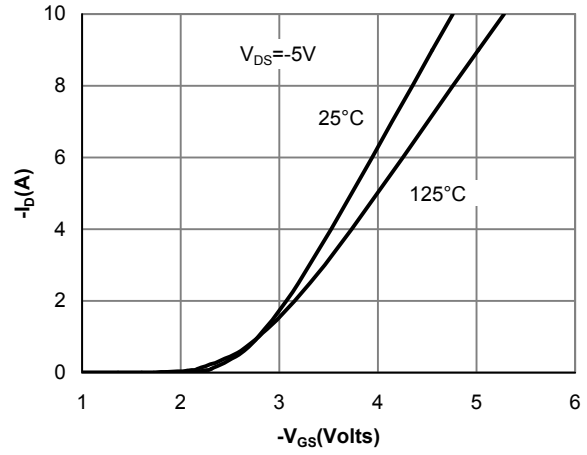

Figure 2: Transfer Characteristics

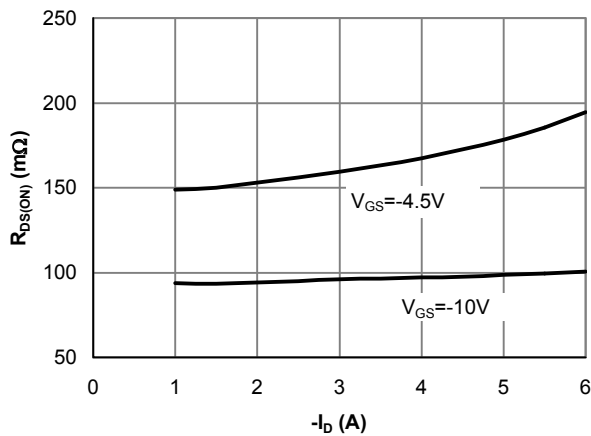

Figure 3: On-Resistance vs. Drain Current and Gate Voltage

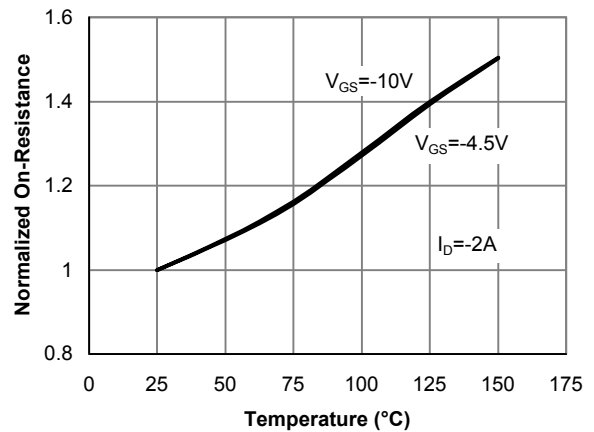

Figure 4: On-Resistance vs. Junction Temperature

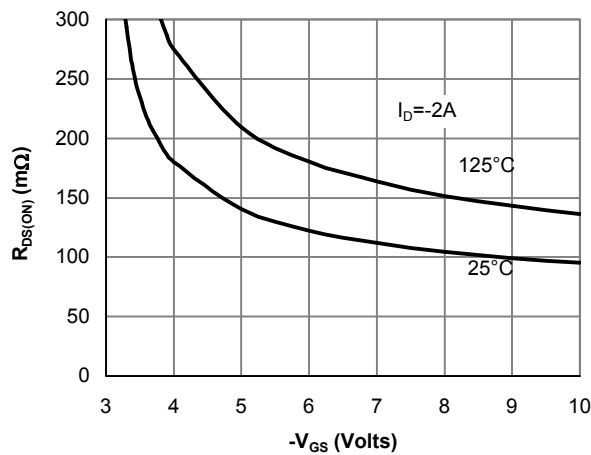

Figure 5: On-Resistance vs. Gate-Source Voltage

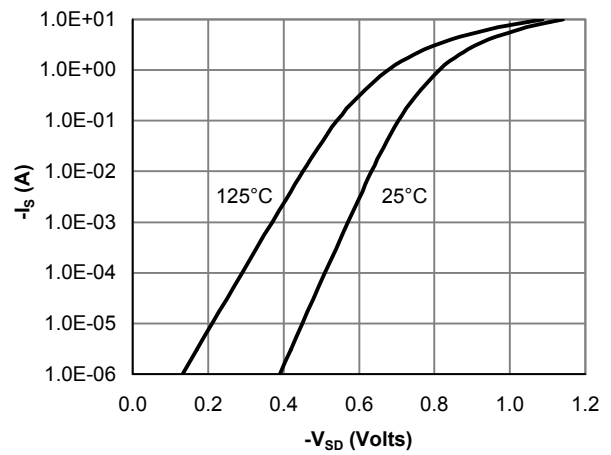

Figure 6: Body-Diode Characteristics

■ Typical Characteristics

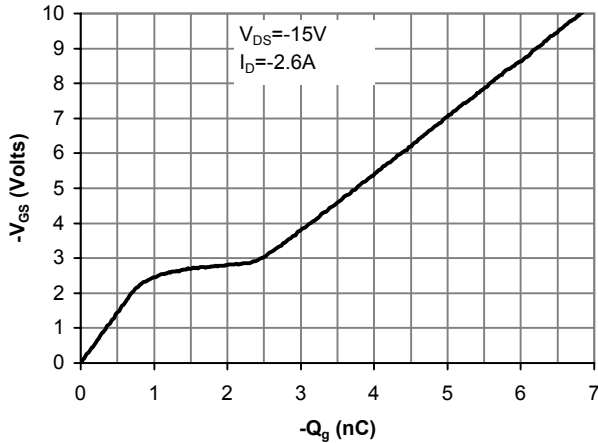

Figure 7: Gate-Charge Characteristics

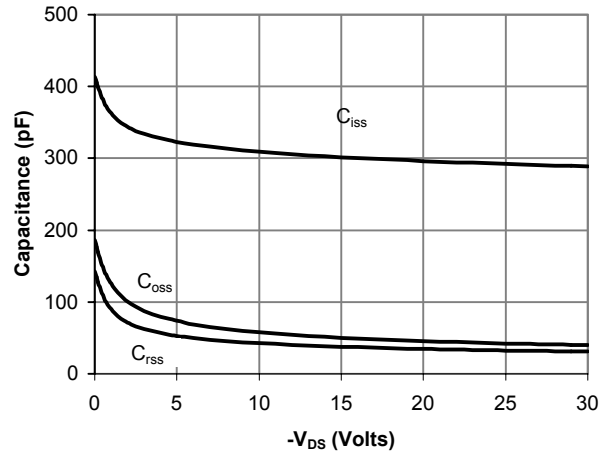

Figure 8: Capacitance Characteristics

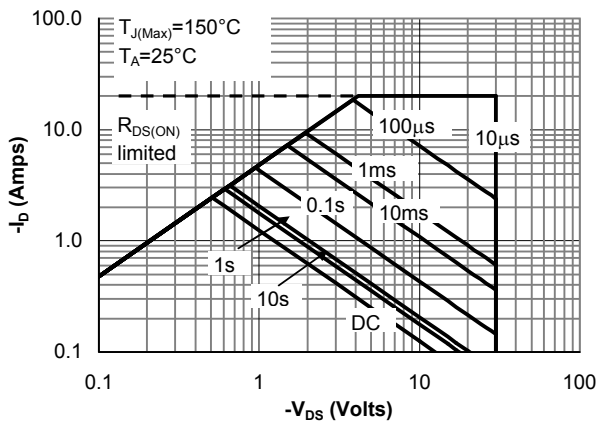

Figure 9: Maximum Forward Biased Safe Operating Area (Note E)

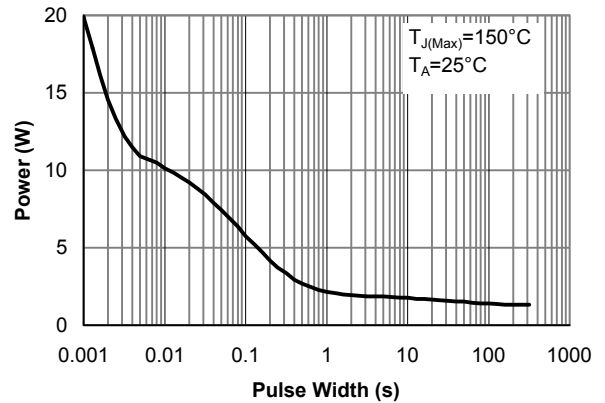

Figure 10: Single Pulse Power Rating Junction-to-Ambient (Note E)

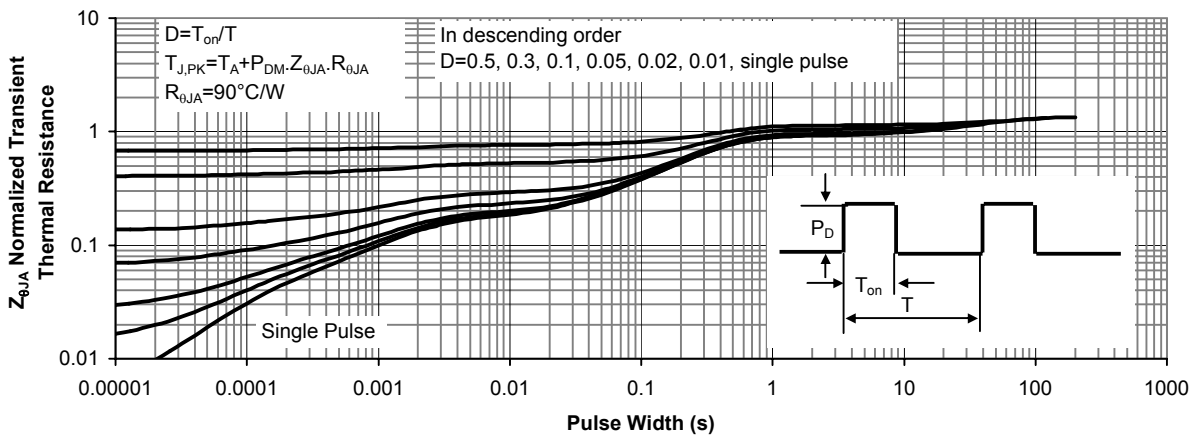
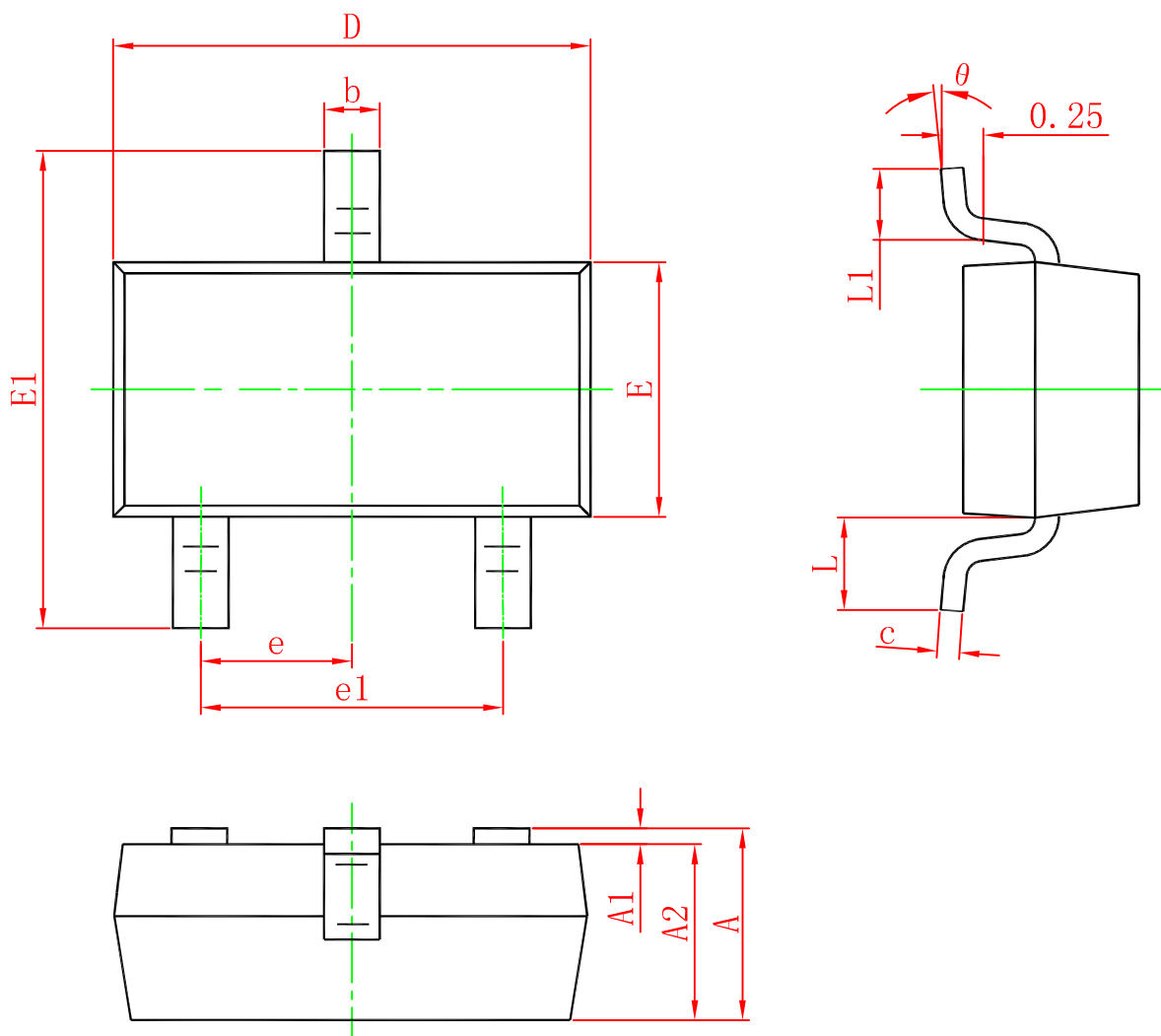

Figure 11: Normalized Maximum Transient Thermal Impedance

SOT-23 PACKAGE OUTLINE DIMENSIONS



Symbol	Dimensions In Millimeters		Dimensions In Inches	
	Min.	Max.	Min.	Max.
A	0.900	1.150	0.035	0.045
A1	0.000	0.100	0.000	0.004
A2	0.900	1.050	0.035	0.041
b	0.300	0.500	0.012	0.020
c	0.080	0.150	0.003	0.006
D	2.800	3.000	0.110	0.118
E	1.200	1.400	0.047	0.055
E1	2.250	2.550	0.089	0.100
e	0.950 TYP.		0.037 TYP.	
e1	1.800	2.000	0.071	0.079
L	0.550 REF.		0.022 REF.	
L1	0.300	0.500	0.012	0.020
θ	0°	8°	0°	8°